

Engineering Guideline

pac-Carriers Type 9195

for TRICON system TRICONEX TMR PLC



Content

Control system			pac-Carrier				
Signal type	I/O cards type	Channels	Slots	Stahl cable type	pac-Carrier type	ISpac	page
DI	3503E	32	2 x 16	9195/C-017	2 x 9195/21A-TR1-04B7	DI: 9170/10-14-11 9170/10-11-11	5-9
	3504E	64	2 x 16	9195/C-017	2 x 9195/21M-TR1-02G1		11-17
			2 x 16		2 x 9195/21S-TR1-02G1		
DO	3624	16	1 x16	9195/C-017	1 x 9195/21A-TR1-03B7	DO: 9175/10-12-11 9175/10-14-11 9175/10-16-11	19-24
AI	3700A	32	2 x 16	9195/C-017	2 x 9195/21H-TR1-05B7	AI: 9160/13-11-11 9163/13-11-11 9182/10-51-13	25-30
	3704E	64	2 x 16	9195/C-017	2 x 9195/21N-TR1-01G1		31-38
			2 x 16		2 x 9195/21T-TR1-01G1		





pac-Carrier
Types 9195 / 21A – TR1 – 04B7

- For Triconex / Version 9 Tricon System / 3503E
2 x 9195/21A-TR1-04B7
- Signal types: 32 x DI
- pac-Carrier for 16 modules, up to 16 signals
- ISpac isolators DI 9170/10-14-11, 9170/10-14-12 and 9170/10-11-11 can be used
- Customized system Stahl cables 9195/C-017 to Tricon automation systems.
- Redundant power supply with contact and exchangeable fuses
- Horizontal or vertical installation
- Simple installation on DIN rail or mounting plate
- Many labeling possibilities
- Fast and secure installation of the isolators without tools
- Comfortable exchange of the isolators with secured ejector mechanism
- Installation possible in Zone 2 and Div. 2

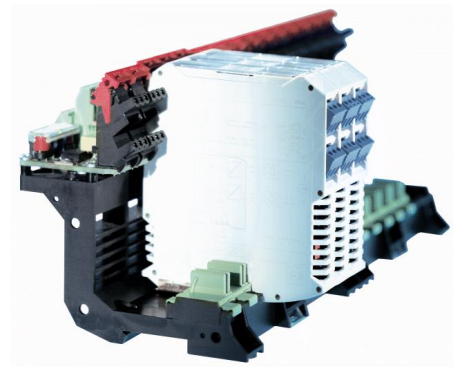

05179E00

Comfortable and simple integration of the I.S. isolators ISpac into Triconex automation systems via system specific connection boards and system cables.

System overview

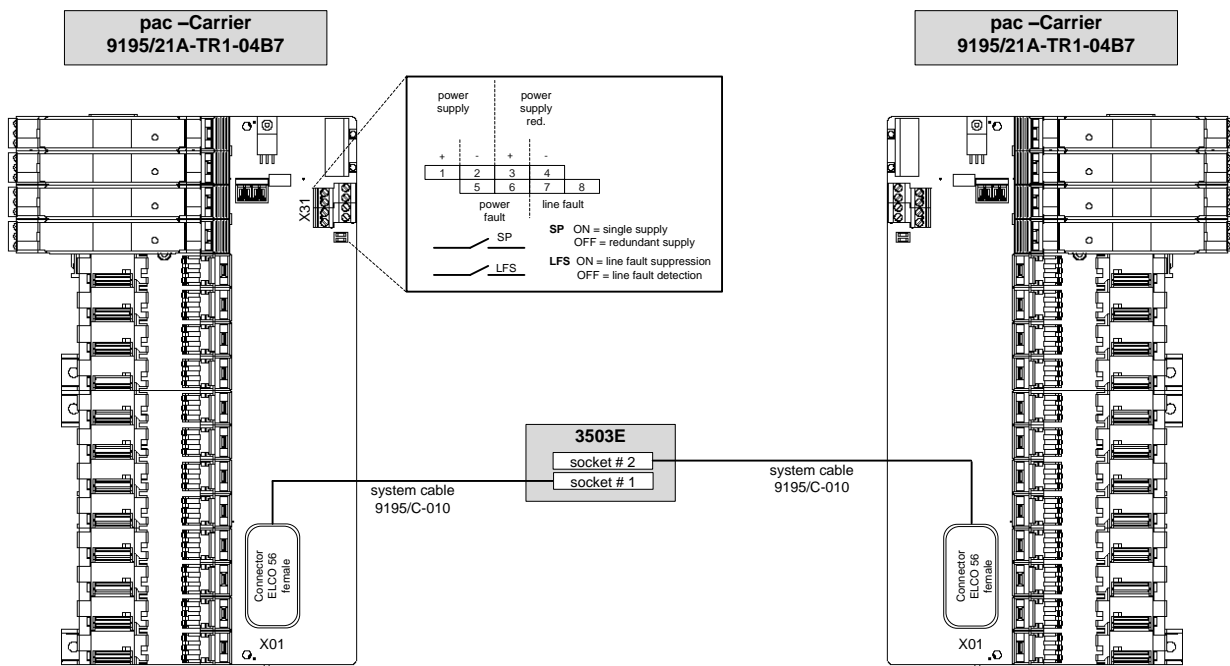

Selection table						
Control system				pac-Carrier		
DLS manufacturer	DLS type	I/O cards type	Signal type	Slots	System cable	Type
Triconex	Version 9 Tricon System	3503E	DI	2 x 16	9195/C-017	2 x 9195/21A-TR1-04B7
Technical data						
Certificates			BVS 03 ATEX E213 X			
Explosion protection			⊕ II 3 G Ex nA nC II T4			
Installation			In Zone 2, Div. 2 and in the safe area			
Power supply			(X31)			
Nominal voltage U _N			24 V DC (19 V ... 31,2 V)			
Redundant supply			yes, decoupled with diodes			
Indication			2 LED green „PWR1“; „PWR2“			
Fuse			2 x TR5; T 2,0 A; exchangeable, for primary and redundant supply			
Polarity reversal protection			yes			
Connection to automation system			(X01)			
Connection			ELCO 56 female, Key-Code: Small 1, Large 3			
Number of channels			16			
Connection field devices – Ex i / I.S.						
Connection			at the terminals of the Ex i isolators (see “signal loops”)			
Number of channels			16			
Error messaging			(X31)			
Power supply failure PF			Contact (35 V / 100 mA), closed in good conditions			
Line fault LF (of IS pac modules)			Contact (35 V / 100 mA), closed in good conditions			
Setting switch „SP“			Power failure message suppressed for single supply			
Setting switch „LFS“			Line fault message suppressed			
Ambient conditions						
Ambient temperature			max. - 20 °C ... + 70 °C (see specification of Ex i isolators)			
Storage temperature			- 40 °C ... + 80 °C			
Relative humidity (no condensation)			≤95 %			
Mechanical data						
Weight			approx. 320 g			
Mounting type			on DIN rail (NS35 / 15, NS35 / 7.5) or mounting plate (4 x screw M6)			
Mounting position			horizontal or vertical			
Casing / Terminal protection class			IP 00 / IP 20			
Casing material			PA 6.6			
Fire protecting class (UL-94)			V0			

Signal loops

The diagrams below show typical applications. Please refer to the connection list to get the entire connection scheme. Basic technical parameters of the ISpac isolating repeaters can be found at the end of this document. The detailed specifications can be downloaded at: www.ispac.info.

Switching repeater (DI)

for NAMUR proximity switches and contacts
- electronic output

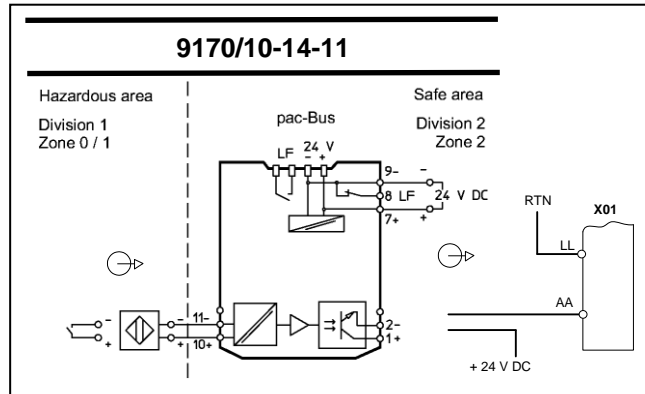

Switching repeater (DI)

with Line Fault Transparency
for NAMUR proximity switches and contacts
- electronic output

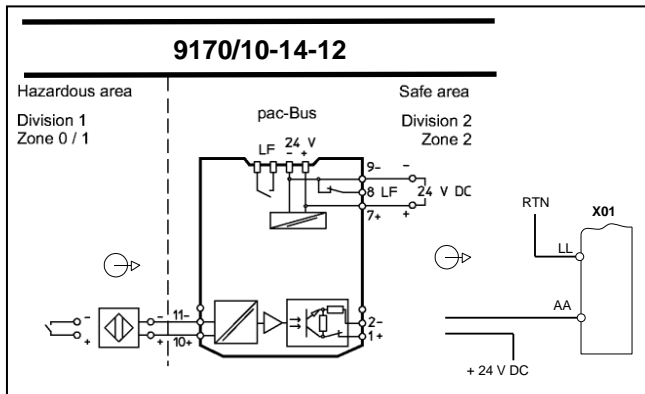

Switching repeater (DI)

for NAMUR proximity switches and contacts
- contact output

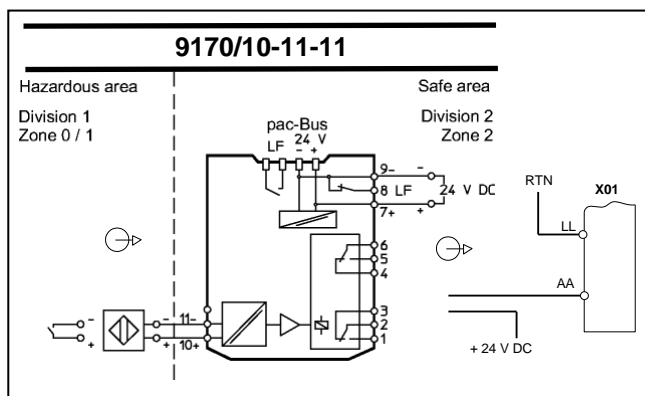



SIL specification

ISpac type	Function	SIL	Tested by	Test report Number	SFF	PFD	Tproof
9195 /21A-TR1-04B7		3	EXIDA	Stahl 04/04-03 R002 (V1, Rev. R1.0)	91%	2.04E-05	10
9170/10-14-11	DI	2	EXIDA	Stahl 05/08-34 R009 (V2, Rev. R0)	88%	5,70E-04	5
9170/10-11-11	DI	2	EXIDA	Stahl 05/08-34 R009 (V2, Rev. R1)	88 %	5,70E-04	5

The pac-Carrier type 9195 is considered as wiring within the SIF.

Accessories and Spare Parts

Designation	Illustration	Description	Order number
Non-Ex i Termination Module	 06314E00	The termination module is used to integrate non-Ex i field circuit into the system integration solution pac-Carrier type 9195. In such a way it enables a flexible mixture of Ex i and non-Ex i field circuits.	9191/20-00-50s
Cover 17,6 yellow transparent (10 pieces)	 01955E00	The yellow covers mark the isolators used for SIL applications. Delivered in packages of 10 pieces.	200914

Dimension drawings (all dimensions in mm) - subject to alterations

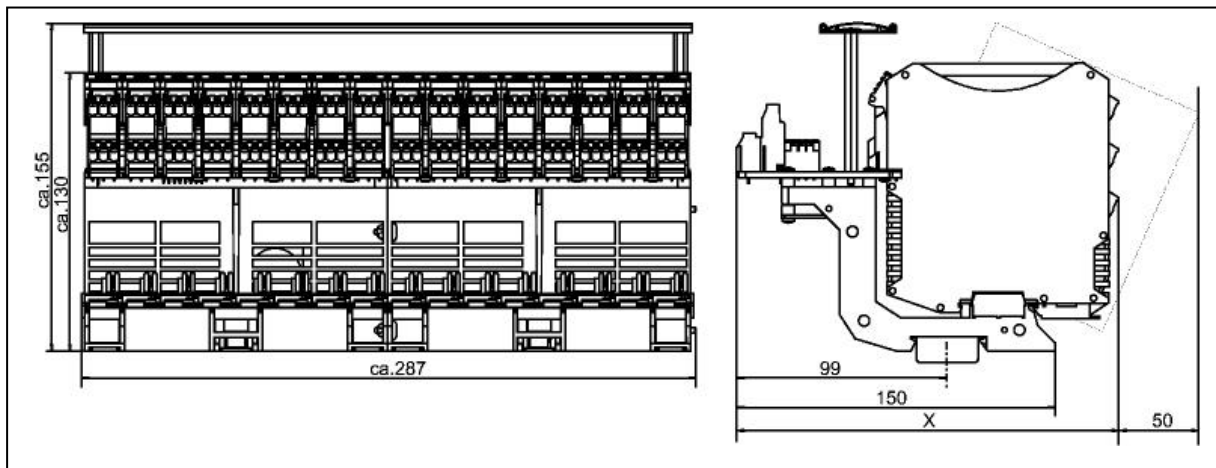

05178E00

	Dimension x
Screw terminals	196 mm
Cage clamp terminals	206 mm

Please note: In order to snap in the ISpac modules an extra space of approx. 50 mm is required. Please read the "ISpac engineering guideline" carefully before you start to engineer the enclosures with incorporated ISpac modules with or without pac-Carriers. The "ISpac engineering guideline" can be downloaded from: www.ispac.info.



Connection list
Connection list – Carrier 1 and 2
TRICONEX Module 3503E (DI 32 com. 24 V)

Terminal i.s.		Channel	Carrier slot	Carrier	Input No.	pin X01 1)		Terminal i.s.		Channel	Carrier slot	Carrier	Input No.	pin X01 1)	
10	11					IN(+)	IN(-)	10	11					IN(+)	IN(-)
+	-	1	1	1	1	AA	LL	+	-	1	1	2	1	AA	LL
+	-	2	2		2	z	EE	+	-	2	2		2	z	EE
+	-	3	3		3	p	v	+	-	3	3		3	p	v
+	-	4	4		4	h	l	+	-	4	4		4	h	l
+	-	5	5		5	e	b	+	-	5	5		5	e	b
+	-	6	6		6	W	S	+	-	6	6		6	W	S
+	-	7	7		7	L	F	+	-	7	7		7	L	F
+	-	8	8		8	M	B	+	-	8	8		8	M	B
+	-	9	9		9	BB	MM	+	-	9	9		9	BB	MM
+	-	10	10		10	CC	HH	+	-	10	10		10	CC	HH
+	-	11	11		11	t	x	+	-	11	11		11	t	x
+	-	12	12		12	j	m	+	-	12	12		12	j	m
+	-	13	13		13	f	c	+	-	13	13		13	f	c
+	-	14	14		14	Z	U	+	-	14	14		14	Z	U
+	-	15	15		15	P	J	+	-	15	15		15	P	J
+	-	16	16		16	N	C	+	-	16	16		16	N	C

1) On terminal X01 Pins T, H, w, FF (CGND) not used.

 We reserve the right to make alterations to the technical data, weights, dimensions, designs and products available without notice.
 The illustration cannot be considered binding.



pac-Carrier

**Types 9195 / 21M – TR1 – 02G1 and
9195 / 21S – TR1 – 02G1**

- **For Triconex / Version 9 Tricon System / 3504E
2 x 9195 / 21M – TR1 – 02G1 (Master) and
2 x 9195 / 21S – TR1 – 02G1 (Slave)**
- Signal types: 64 x DI
- pac-Carrier for 16 modules, up to 16 signals
- ISpac isolator DI 9170/10-14-11, 9170/10-14-12 and 9170/10-11-11 can be used
- Customized system cables type 9195/C-017 to automation systems (Master)
- Redundant power supply with message contact and exchangeable fuses
- Horizontal or vertical installation
- Simple installation on DIN rail or mounting plate
- Many labeling possibilities
- Fast and secure installation of the isolators without tools
- Comfortable exchange of the isolators with secured ejector mechanism
- Installation possible in Zone 2 and Div. 2

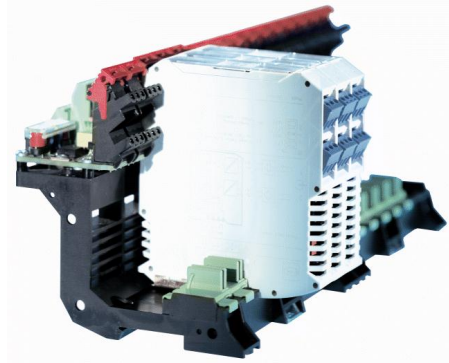

05179E00

Comfortable and simple integration of the I.S. isolators ISpac into Triconex automation systems via system specific connection boards and system cables.

System overview

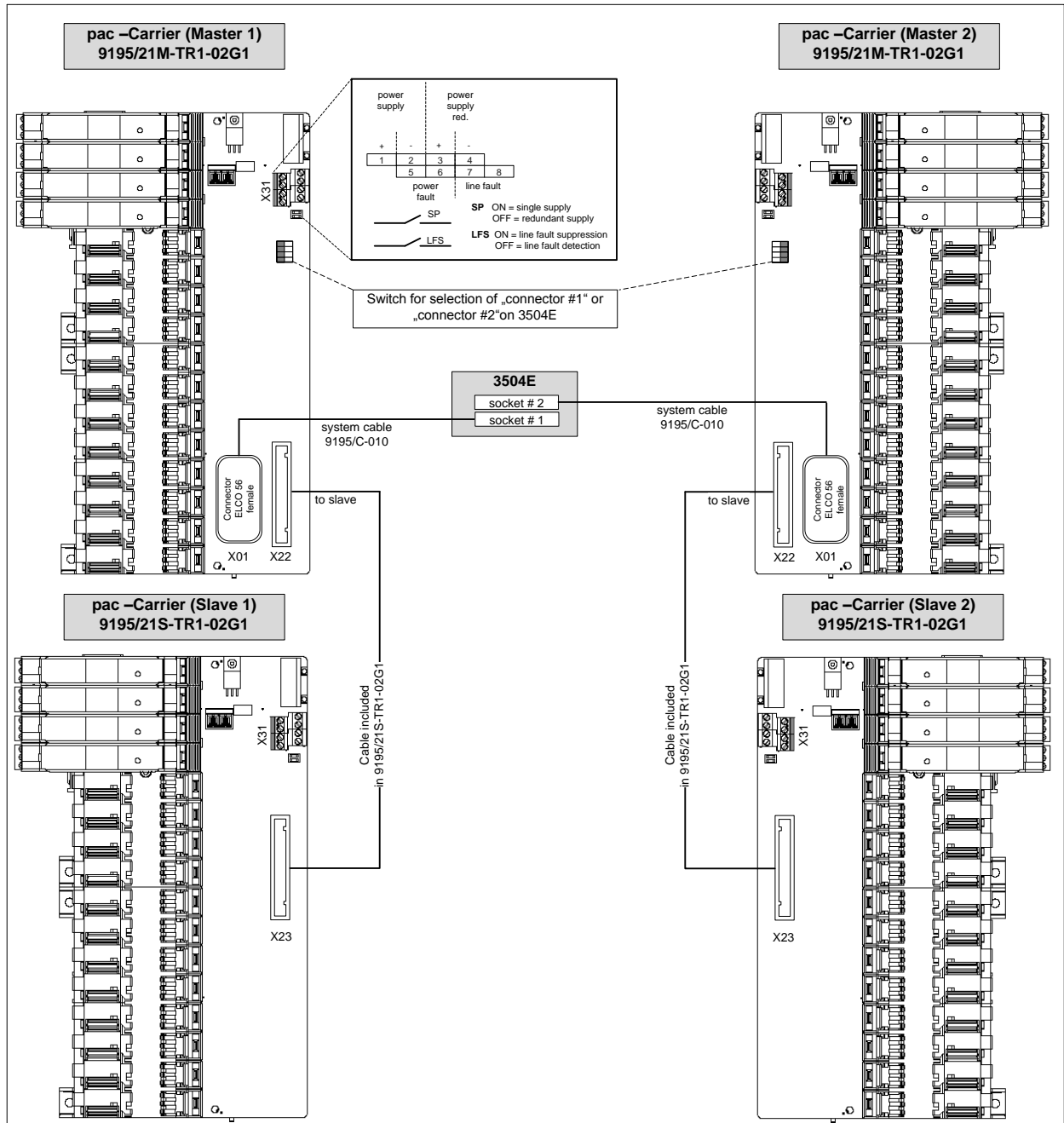

Selection table						
Control system				pac-Carrier		
DLS manufacturer	DLS type	I/O cards type	Signal type	Slots	System cable	Type
Triconex	Version 9 Tricon System	3504E	DI	2 x 16	2 x 9195/C-017	2 x 9195/21M-TR1-02G1
				2 x 16	--	2 x 9195/21S-TR1-02G1
Technical data						
Certificates			BVS 03 ATEX E213 X			
Explosion protection			⊕ II 3 G Ex nA nC II T4			
Installation			In Zone 2, Div. 2 and in the safe area			
Power supply			(X31)			
Nominal voltage U_N			24 V DC (19 V ... 31,2 V)			
Redundant supply			yes, decoupled with diodes			
Indication			2 LED green „PWR1“; „PWR2“			
Fuse			2 x TR5; T 2,0 A; exchangeable, for primary and redundant supply			
Polarity reversal protection			yes			
Connection to automation system			(X01)			
Connection			ELCO 56 female, Key-Code: Small 1, Large 3			
Number of channels			32			
Connection field devices – Ex i / I.S.						
Connection			at the terminals of the Ex i isolators (see “signal loops”)			
Number of channels			16			
Connection to SLAVE carrier			(X22)			
Connection			IEC 60603-13 (DIN 41651) 34 pole, male			
Number of channels			16			
Connection to MASTER carrier			(X23)			
Connection			IEC 60603-13 (DIN 41651) 34 pole, male			
Number of channels			16			
Error messaging			(X31)			
Power supply failure PF			Contact (35 V / 100 mA), closed in good conditions			
Line fault LF (of IS pac modules)			Contact (35 V / 100 mA), closed in good conditions			
Setting switch „SP“			Power failure message suppressed for redundant supply (single supply)			
Setting switch „LFS“			Line fault message suppressed			
Ambient conditions						
Ambient temperature			max. - 20 °C ... + 70 °C (see specification of Ex i isolators)			
Storage temperature			- 40 °C ... + 80 °C			
Relative humidity (no condensation)			≤95 %			
Mechanical data						
Weight			approx. 320 g			
Mounting type			on DIN rail (NS35 / 15, NS35 / 7.5) or mounting plate (4 x screw M6)			
Mounting position			horizontal or vertical			
Casing / Terminal protection class			IP 00 / IP 20			
Casing material			PA 6.6			
Fire protecting class (UL-94)			V0			

Signal loops

The diagrams below show typical applications. Please refer to the connection list to get the entire connection scheme. Basic technical parameters of the ISpac isolating repeaters can be found at the end of this document. The detailed specifications can be downloaded at: www.ispac.info.

Switching repeater (DI)

for NAMUR proximity switches and contacts
- electronic output

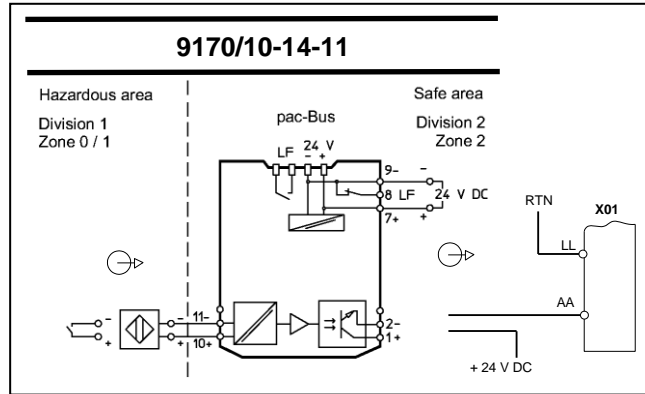

Switching repeater (DI)

with Line Fault Transparency
for NAMUR proximity switches and contacts
- electronic output

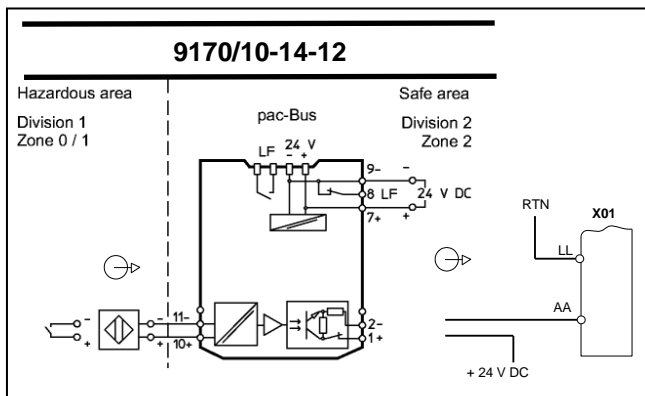

Switching repeater (DI)

for NAMUR proximity switches and contacts
- contact output

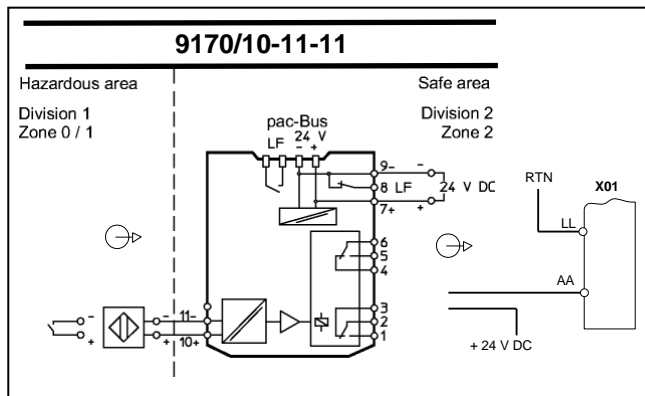



SIL specification

ISpac type	Function	SIL	Tested by	Test report Number	SFF	PFD	Tproof
9195/21M-TR1-02G1		3	EXIDA	Stahl 04/04-03 R002 (V1, Rev. R1.0)	91%	2.04E-05	10
9195/21S-TR1-02G1		3	EXIDA	Stahl 04/04-03 R002 (V1, Rev. R1.0)	91%	2.04E-05	10
9170/10-14-11	DI	2	EXIDA	Stahl 05/08-34 R009 (V2, Rev. R0)	88%	5,70E-04	5
9170/10-11-11	DI	2	EXIDA	Stahl 05/08-34 R009 (V2, Rev. R1)	88%	5,70E-04	5

The pac-Carrier type 9195 is considered as wiring within the SIF.



Accessories and Spare Parts

Designation	Illustration	Description	Order number
Non-Ex i Termination Module	 06314E00	The termination module is used to integrate non-Ex i field circuit into the system integration solution pac-Carrier type 9195. In such a way it enables a flexible mixture of Ex i and non-Ex i field circuits.	9191/20-00-50s
Cover 17,6 yellow transparent (10 pieces)	 01955E00	The yellow covers mark the isolators used for SIL applications. Delivered in packages of 10 pieces.	200914

Dimension drawings (all dimensions in mm) - subject to alterations

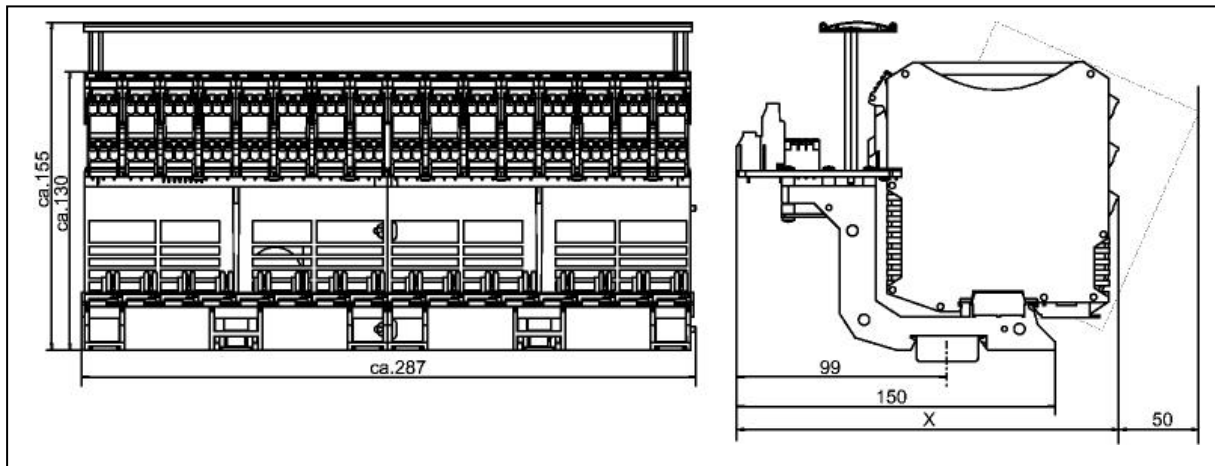

05178E00

	Dimension x
Screw terminals	196 mm
Cage clamp terminals	206 mm

Please note: In order to snap in the ISpac modules an extra space of approx. 50 mm is required. Please read the "ISpac engineering guideline" carefully before you start to engineer the enclosures with incorporated ISpac modules with or without pac-Carriers. The "ISpac engineering guideline" can be downloaded from: www.ispac.info.



Connection list

Connection list – Master 1 and 2 TRICONEX Module 3504E (DI 64 com. 24 V)

terminal I.S. 1)		channel	carrier slot	carrier	input no.	pin X01 conn. # 1 (Elco 56 female)	terminal I.S. 1)		channel	carrier slot	carrier	input no.	pin X01 conn. # 2 (Elco 56 female)
10	+	1	1	Master 1	1	AA	10	+	33	1	Master 2	33	AA
11	-							-					
10	+	2	2		2	LL	10	+	34	2		34	LL
11	-							-					
10	+	3	3		3	z	10	+	35	3		35	z
11	-							-					
10	+	4	4		4	EE	10	+	36	4		36	EE
11	-							-					
10	+	5	5		5	p	10	+	37	5		37	p
11	-							-					
10	+	6	6		6	v	10	+	38	6		38	v
11	-							-					
10	+	7	7		7	h	10	+	39	7		39	h
11	-							-					
10	+	8	8		8	l	10	+	40	8		40	l
11	-							-					
10	+	9	9	9	e	10	+	41	9	41	e		
11	-						-					-	11
10	+	10	10	10	b	10	+	42	10	42	b		
11	-						-					-	11
10	+	11	11	11	W	10	+	43	11	43	W		
11	-						-					-	11
10	+	12	12	12	S	10	+	44	12	44	S		
11	-						-					-	11
10	+	13	13	13	L	10	+	45	13	45	L		
11	-						-					-	11
10	+	14	14	14	F	10	+	46	14	46	F		
11	-						-					-	11
10	+	15	15	15	M	10	+	47	15	47	M		
11	-						-					-	11
10	+	16	16	16	B	10	+	48	16	48	B		
11	-						-					-	11

We reserve the right to make alterations to the technical data, weights, dimensions, designs and products available without notice.
The illustration cannot be considered binding.

Connection list – Slave 1 and 2
TRICONEX Module 3504E (DI 64 com. 24 V)

terminal I.S. 1)		channel	carrier slot	carrier	input no.	pin X01 conn. # 1 (Elco 56 female)	terminal I.S. 1)		channel	carrier slot	carrier	input no.	pin X01 conn. # 2 (Elco 56 female)
10	+	17	1	Slave 1	17	BB	10	+	49	1	Slave 2	49	BB
11	-						11	-					
10	+	18	2		18	MM	10	+	51	3		51	CC
11	-						11	-					
10	+	19	3		19	CC	10	+	53	5		53	t
11	-						11	-					
10	+	20	4		20	HH	10	+	55	7		55	j
11	-						11	-					
10	+	21	5		21	t	10	+	57	9		57	f
11	-						11	-					
10	+	22	6		22	x	10	+	59	11		59	Z
11	-						11	-					
10	+	23	7		23	j	10	+	61	13		61	P
11	-						11	-					
10	+	24	8		24	m	10	+	63	15		63	N
11	-						11	-					
10	+	25	9	25	f	10	+	64	16	64	C		
11	-					11	-						
10	+	26	10	26	c								
11	-					11	-						
10	+	27	11	27	Z								
11	-					11	-						
10	+	28	12	28	U								
11	-					11	-						
10	+	29	13	29	P								
11	-					11	-						
10	+	30	14	30	J								
11	-					11	-						
10	+	31	15	31	N								
11	-					11	-						
10	+	32	16	32	C								
11	-					11	-						



pac-Carrier
Type 9195/21A-TR1-03B7

- For Triconex / Version 9 Tricon System / 3624
- Signal types: 16 x DO
- pac-Carrier for 16 modules, up to 16 signals
- ISpac isolator DO 9175/10-12-11, 9175/10-14-11, 9175/10-16-11 can be used
- Customized system cables type ELCO 56 to automation systems
- Redundant power supply with message contact and exchangeable fuses
- Horizontal or vertical installation
- Simple installation on DIN rail or mounting plate
- Many labeling possibilities
- Fast and secure installation of the isolators without tools
- Comfortable exchange of the isolators with secured ejector mechanism
- Installation possible in Zone 2 and Div. 2

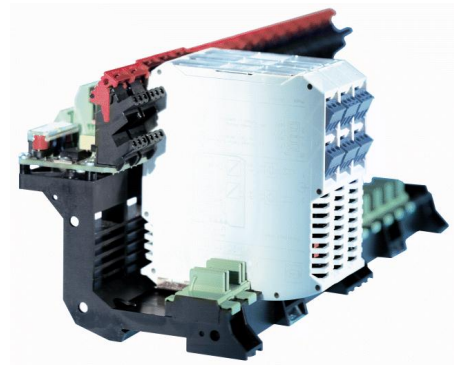

05179E00

Comfortable and simple integration of the I.S. isolators ISpac into Triconex automation systems via system specific connection boards and system cables.

System overview

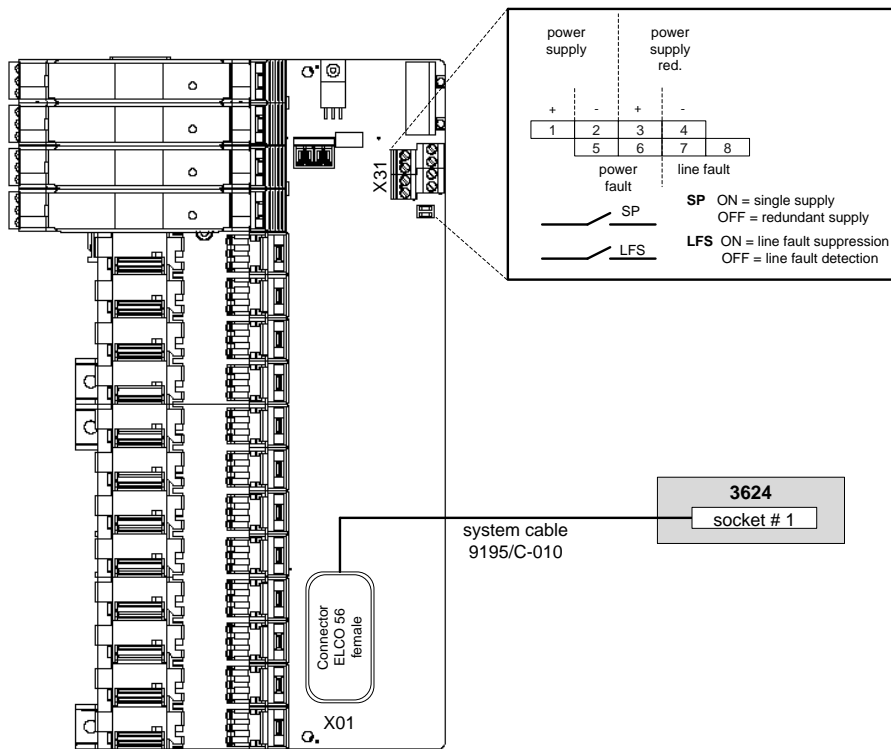

Selection table						
Control system				pac-Carrier		
DLS manufacturer	DLS type	I/O cards type	Signal type	Slots	System cable	Type
Triconex	Version 9 Tricon System	3624	DO	16	9195/C-017	9195/21A-TR1-03B7
Technical data						
Certificates			BVS 03 ATEX E213 X			
Explosion protection			⊕ II 3 G Ex nA nC II T4			
Installation			In Zone 2, Div. 2 and in the safe area			
Power supply			(X31)			
Nominal voltage U_N			24 V DC (19 V ... 31,2 V)			
Redundant supply			yes, decoupled with diodes			
Indication			2 LED green „PWR1“; „PWR2“			
Fuse			2 x TR5; T 2,0 A; exchangeable, for primary and redundant supply			
Polarity reversal protection			yes			
Connection to automation system			(X01)			
Connection			ELCO 56 female, Key-Code: Small 3, Large 3			
Number of channels			16			
Connection field devices – Ex i / I.S.						
Connection			at the terminals of the Ex i isolators (see “signal loops”)			
Number of channels			16			
Error messaging			(X31)			
Power supply failure PF			Contact (35 V / 100 mA), closed in good conditions			
Line fault LF (of IS pac modules)			Contact (35 V / 100 mA), closed in good conditions			
Setting switch „SP“			Power failure message suppressed for redundant supply (single supply)			
Setting switch „LFS“			Line fault message suppressed			
Ambient conditions						
Ambient temperature			max. - 20 °C ... + 70 °C (see specification of Ex i isolators)			
Storage temperature			- 40 °C ... + 80 °C			
Relative humidity (no condensation)			≤95 %			
Mechanical data						
Weight			approx. 320 g			
Mounting type			on DIN rail (NS35 / 15, NS35 / 7.5) or mounting plate (4 x screw M6)			
Mounting position			horizontal or vertical			
Casing / Terminal protection class			IP 00 / IP 20			
Casing material			PA 6.6			
Fire protecting class (UL-94)			V0			

Signal loops

The diagrams below show typical applications. Please refer to the connection list to get the entire connection scheme. Basic technical parameters of the ISpac isolating repeaters can be found at the end of this document. The detailed specifications can be downloaded at: www.ispac.info.

Digital Output (DO)

for Solenoid valves and indicators

Please check the holding current of the solenoid valve by means of the individual spec sheet.

Line fault detection circuit ISpac 9175: Current: 0,5...1,1 mA

If necessary, LFD can be switched off

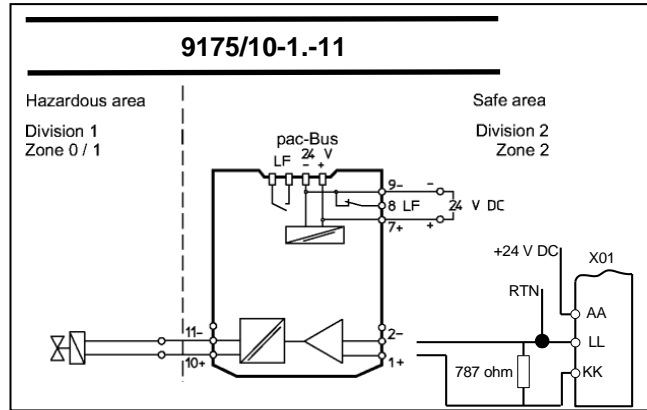



SIL specification

ISpac type	Function	SIL	Tested by	Test report Number	SFF	PFD	Tproof
9195/21A-TR1-03B7		3	EXIDA	Stahl 04/04-03 R002 (V1, Rev. R1.0)	91%	2.04E-05	10
9175/10-1*-11	DO	3	EXAM	PB06/04X (23.06.05) (Rev. B)	99%	8,12E-05	3

The pac-Carrier type 9195 is considered as wiring within the SIF.

Accessories and Spare Parts

Designation	Illustration	Description	Order number
Non-Ex i Termination Module	 06314E00	The termination module is used to integrate non-Ex i field circuit into the system integration solution pac-Carrier type 9195. In such a way it enables a flexible mixture of Ex i and non-Ex i field circuits.	9191/20-00-50s
Cover 17,6 yellow transparent (10 pieces)	 01955E00	The yellow covers mark the isolators used for SIL applications. Delivered in packages of 10 pieces.	200914

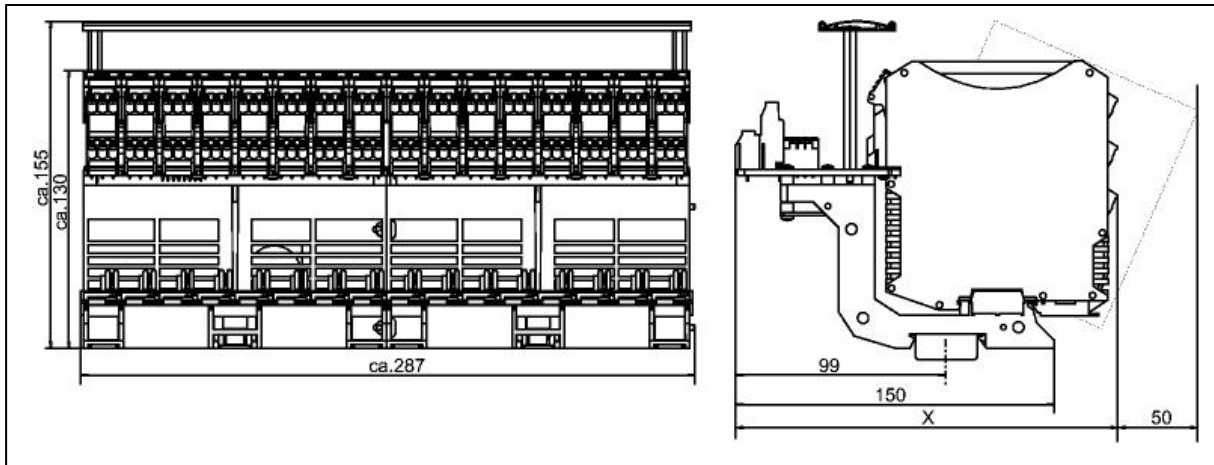

Dimension drawings (all dimensions in mm) - subject to alterations

05178E00

	Dimension x
Screw terminals	196 mm
Cage clamp terminals	206 mm

Please note: In order to snap in the ISpac modules an extra space of approx. 50 mm is required.
Please read the "ISpac engineering guideline" carefully before you start to engineer the enclosures with incorporated ISpac modules with or without pac-Carriers. The "ISpac engineering guideline" can be downloaded from: www.ispac.info.

Connection list
TRICONEX Module 3624 (DO 16 at 24 V)

Channel	Terminal i.s.		Carrier slot	Terminal X01 1)			Output No.
				PWR	RTN	LOAD	
1	10	+	1	AA	LL	KK	1
	11	-					
2	10	+	2	z	EE	DD	2
	11	-					
3	10	+	3	p	v	u	3
	11	-					
4	10	+	4	h	l	k	4
	11	-					
5	10	+	5	e	b	a	5
	11	-					
6	10	+	6	W	S	R	6
	11	-					
7	10	+	7	L	F	E	7
	11	-					
8	10	+	8	M	B	A	8
	11	-					
9	10	+	9	BB	MM	NN	9
	11	-					
10	10	+	10	CC	HH	JJ	10
	11	-					
11	10	+	11	t	x	y	11
	11	-					
12	10	+	12	j	m	n	12
	11	-					
13	10	+	13	f	c	d	13
	11	-					
14	10	+	14	Z	U	V	14
	11	-					
15	10	+	15	P	J	K	15
	11	-					
16	10	+	16	N	C	D	16
	11	-					

On terminal X01 Pins T, H, w, FF are CGND



pac-Carrier
Types 9195 / 21H – TR1 – 05B7

- For Triconex / Version 9 Tricon System / 3700A
2 x 9195/21H-TR1-05B7
- Signal types: 32 x AI
- pac-Carrier for 16 modules, up to 16 signals
- ISpac isolator AI 9160/13-11-11, 9163/13-11-11, 9182/10-51-13 can be used
- Customized system cables type 9195/C-017 to automation systems (Master)
- Redundant power supply with message contact and exchangeable fuses
- Horizontal or vertical installation
- Simple installation on DIN rail or mounting plate
- Many labeling possibilities
- Fast and secure installation of the isolators without tools
- Comfortable exchange of the isolators with secured ejector mechanism
- Installation possible in Zone 2 and Div. 2

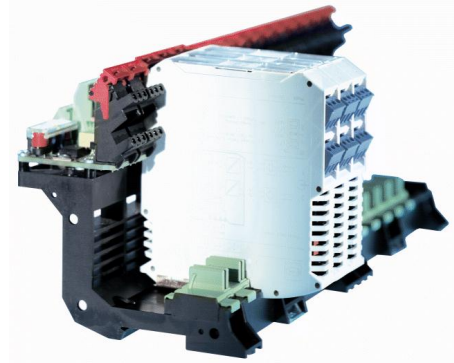

05179E00

Comfortable and simple integration of the I.S. isolators ISpac into Triconex automation systems via system specific connection boards and system cables.

System overview

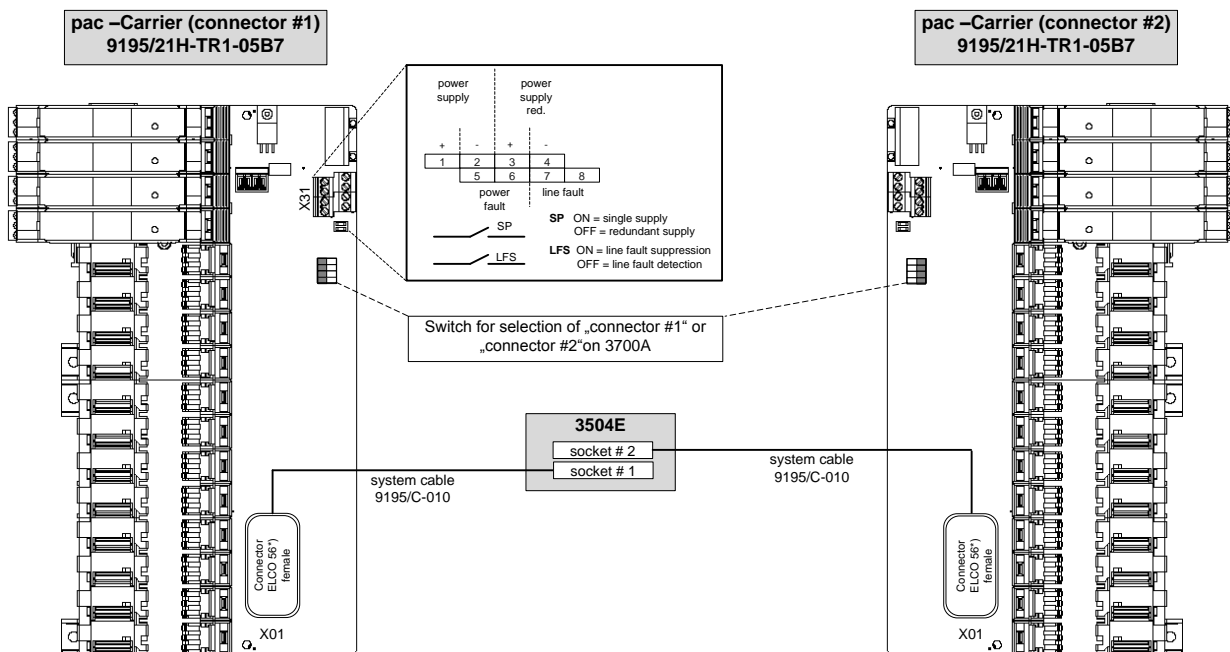

Selection table						
Control system				pac-Carrier		
DLS manufacturer	DLS type	I/O cards type	Signal type	Slots	System cable	Type
Triconex	Version 9 Tricon System	3700A	DI	2 x 16	9195/C-017	2 x 9195/21H-TR1-05B7
Technical data						
Certificates			BVS 03 ATEX E213 X			
Explosion protection			⊕ II 3 G Ex nA nC II T4			
Installation			In Zone 2, Div. 2 and in the safe area			
Power supply			(X31)			
Nominal voltage U_N			24 V DC (19 V ... 31,2 V)			
Redundant supply			yes, decoupled with diodes			
Indication			2 LED green „PWR1“; „PWR2“			
Fuse			2 x TR5; T 2,0 A; exchangeable, for primary and redundant supply			
Polarity reversal protection			yes			
Connection to automation system			(X01)			
Connection			ELCO 56 female, Key-Code: Small 1, Large 5			
Number of channels			32			
Connection field devices – Ex i / I.S.						
Connection			at the terminals of the Ex i isolators (see “signal loops”)			
Number of channels			16			
Error messaging			(X31)			
Power supply failure PF			Contact (35 V / 100 mA), closed in good conditions			
Line fault LF (of IS pac modules)			Contact (35 V / 100 mA), closed in good conditions			
Setting switch „SP“			Power failure message suppressed for redundant supply (single supply)			
Setting switch „LFS“			Line fault message suppressed			
Ambient conditions						
Ambient temperature			max. - 20 °C ... + 70 °C (see specification of Ex i isolators)			
Storage temperature			- 40 °C ... + 80 °C			
Relative humidity (no condensation)			≤95 %			
Mechanical data						
Weight			approx. 320 g			
Mounting type			on DIN rail (NS35 / 15, NS35 / 7.5) or mounting plate (4 x screw M6)			
Mounting position			horizontal or vertical			
Casing / Terminal protection class			IP 00 / IP 20			
Casing material			PA 6.6			
Fire protecting class (UL-94)			V0			

Signal loops

The diagrams below show typical applications. Please refer to the connection list to get the entire connection scheme. Basic technical parameters of the ISpac isolating repeaters can be found at the end of this document. The detailed specifications can be downloaded at: www.ispac.info.

Transmitter supply unit (AI)
for 2-,3- wire transmitter and mA- sources
for 2- wire transmitter with HART

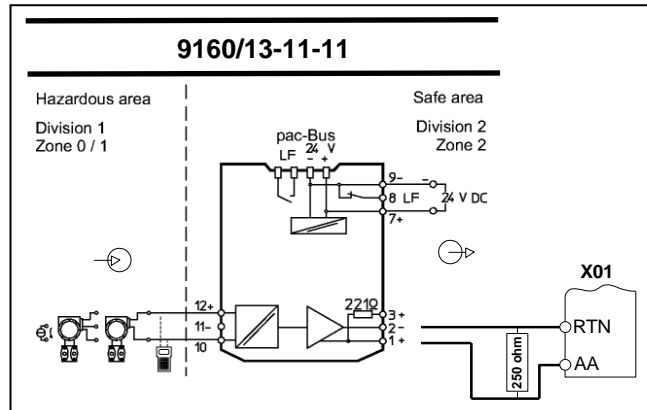

Isolating repeater (AI)
for 4- wire transmitter and mA- sources
bi- directional HART communication

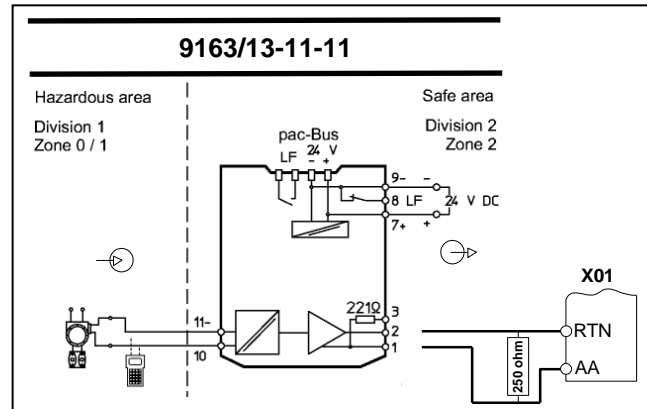

Temperature transmitter (AI)
for resistance thermometer,
thermocouple and RTD
(Configuration by means of ISpac Wizard software)
(Verification test with SIS 1508 pending)

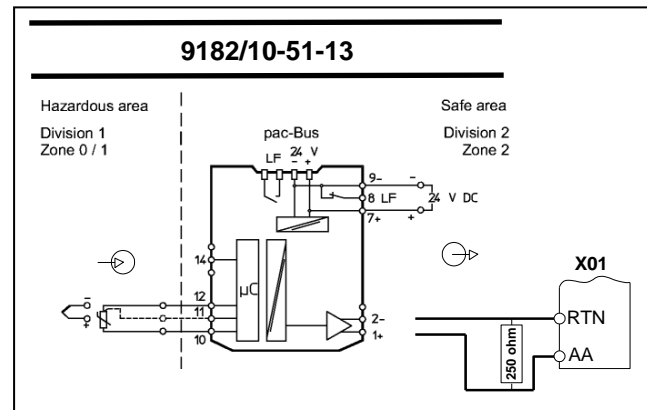



SIL specification

ISpac type	Function	SIL	Tested by	Test report Number	SFF	PFD	Tproof
9195/16M-TR1-01G1		3	EXIDA	Stahl 04/04-03 R002 (V1, Rev. R1.0)	91%	2.04E-05	10
9195/16S-TR1-01H1							
9160/13-11-11	AI	2	EXIDA	Stahl 05/08-34 R008 (V2, Rev. R2)	73%	4,64E-04	1
9163/13-11-11	AI	2	EXIDA	Stahl 08/10-21 R015 (V1, Rev. R0)	77.5%	4,62E-04	1
9182/10-51-13	TI	2	EXIDA	Stahl 07/07-23 R016 (V1, Rev. R1)	78%	7.59E-04	1

The pac-Carrier type 9195 is considered as wiring within the SIF.

Accessories and Spare Parts

Designation	Illustration	Description	Order number
Non-Ex i Termination Module	 06314E00	The termination module is used to integrate non-Ex i field circuit into the system integration solution pac-Carrier type 9195. In such a way it enables a flexible mixture of Ex i and non-Ex i field circuits.	9191/20-00-50s
Cover 17,6 yellow transparent (10 pieces)	 01955E00	The yellow covers mark the isolators used for SIL applications. Delivered in packages of 10 pieces.	200914

Dimension drawings (all dimensions in mm) - subject to alterations

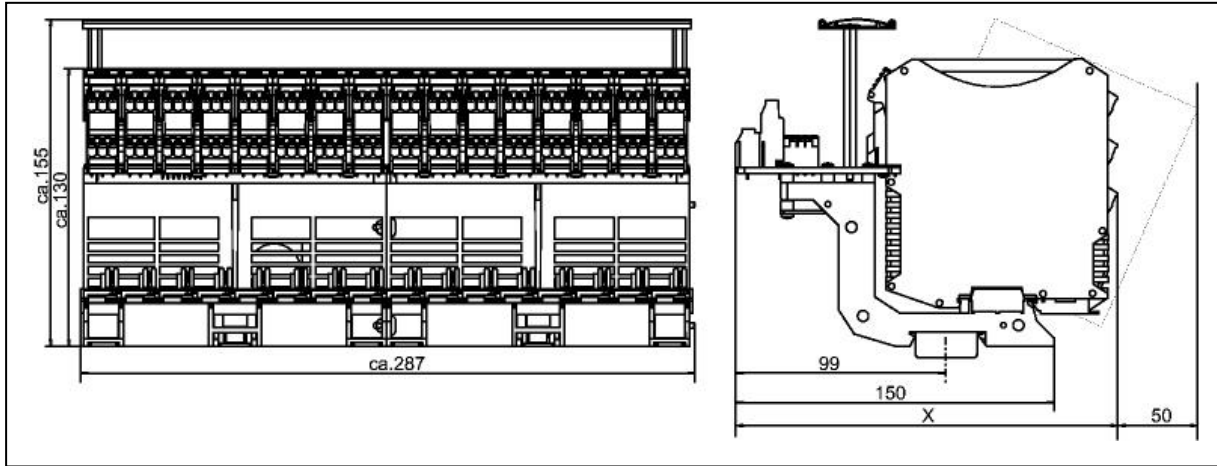

05178E00

	Dimension x
Screw terminals	196 mm
Cage clamp terminals	206 mm

Please note: In order to snap in the ISpac modules an extra space of approx. 50 mm is required.
 Please read the "ISpac engineering guideline" carefully before you start to engineer the enclosures with incorporated ISpac modules with or without pac-Carriers. The "ISpac engineering guideline" can be downloaded from: www.ispac.info.



Connection list

Connection list – Connector 1 and 2 TRICONEX Module 3700A (AI 32, 0-5 V)

terminal I.S.		channel	carrier slot	carrier input no.	pin X01 conn. # 1 (Elco 56 female)	terminal I.S.		channel	carrier slot	carrier input no.	pin X01 conn. # 2 (Elco 56 female)						
1)						1)											
10	+	1	1	Connector # 1	1	AA	10	+	33	1	Connector # 2	33	AA				
11	-						11	-									
10	+	2	2				2	LL	10	+				34	2	34	LL
11	-						11	-	11	-						11	-
10	+	3	3				3	z	10	+				35	3	35	z
11	-						11	-	11	-						11	-
10	+	4	4				4	EE	10	+				36	4	36	EE
11	-						11	-	11	-						11	-
10	+	5	5				5	p	10	+				37	5	37	p
11	-						11	-	11	-						11	-
10	+	6	6				6	v	10	+				38	6	38	v
11	-						11	-	11	-						11	-
10	+	7	7				7	h	10	+				39	7	39	h
11	-						11	-	11	-						11	-
10	+	8	8				8	l	10	+				40	8	40	l
11	-						11	-	11	-						11	-
10	+	9	9	9	e	10	+	41	9	41	e						
11	-			11	-	11	-			11	-						
10	+	10	10	10	b	10	+	42	10	42	b						
11	-			11	-	11	-			11	-						
10	+	11	11	11	W	10	+	43	11	43	W						
11	-			11	-	11	-			11	-						
10	+	12	12	12	S	10	+	44	12	44	S						
11	-			11	-	11	-			11	-						
10	+	13	13	13	L	10	+	45	13	45	L						
11	-			11	-	11	-			11	-						
10	+	14	14	14	F	10	+	46	14	46	F						
11	-			11	-	11	-			11	-						
10	+	15	15	15	M	10	+	47	15	47	M						
11	-			11	-	11	-			11	-						
10	+	16	16	16	B	10	+	48	16	48	B						
11	-			11	-	11	-			11	-						

We reserve the right to make alterations to the technical data, weights, dimensions, designs and products available without notice.
The illustration cannot be considered binding.

pac-Carrier
Types 9195 / 21N – TR1 – 01G1 and
9195 / 21T – TR1 – 01G1

- **For Triconex / Version 9 Tricon System / 3704E**
2 x 9195/21N-TR1-01G1 and
2 x 9195/21T-TR1-01G1
- Signal types: 64 x AI
- pac-Carrier for 16 modules, up to 16 signals
- ISpac isolator AI 9160/13-11-11, 9163/13-11-11, 9182/10-51-13 can be used
- Customized system cables type 9195/C-017 to automation systems (Master)
- Redundant power supply with message contact and exchangeable fuses
- Horizontal or vertical installation
- Simple installation on DIN rail or mounting plate
- Many labeling possibilities
- Fast and secure installation of the isolators without tools
- Comfortable exchange of the isolators with secured ejector mechanism
- Installation possible in Zone 2 and Div. 2

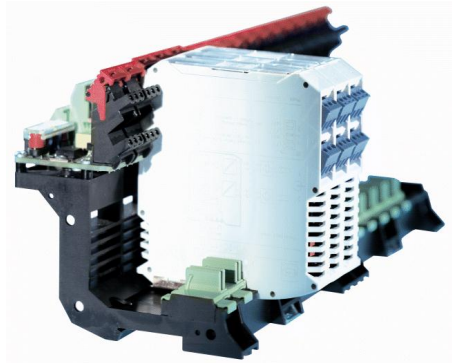

05179E00

Comfortable and simple integration of the I.S. isolators ISpac into Triconex automation systems via system specific connection boards and system cables.

System overview

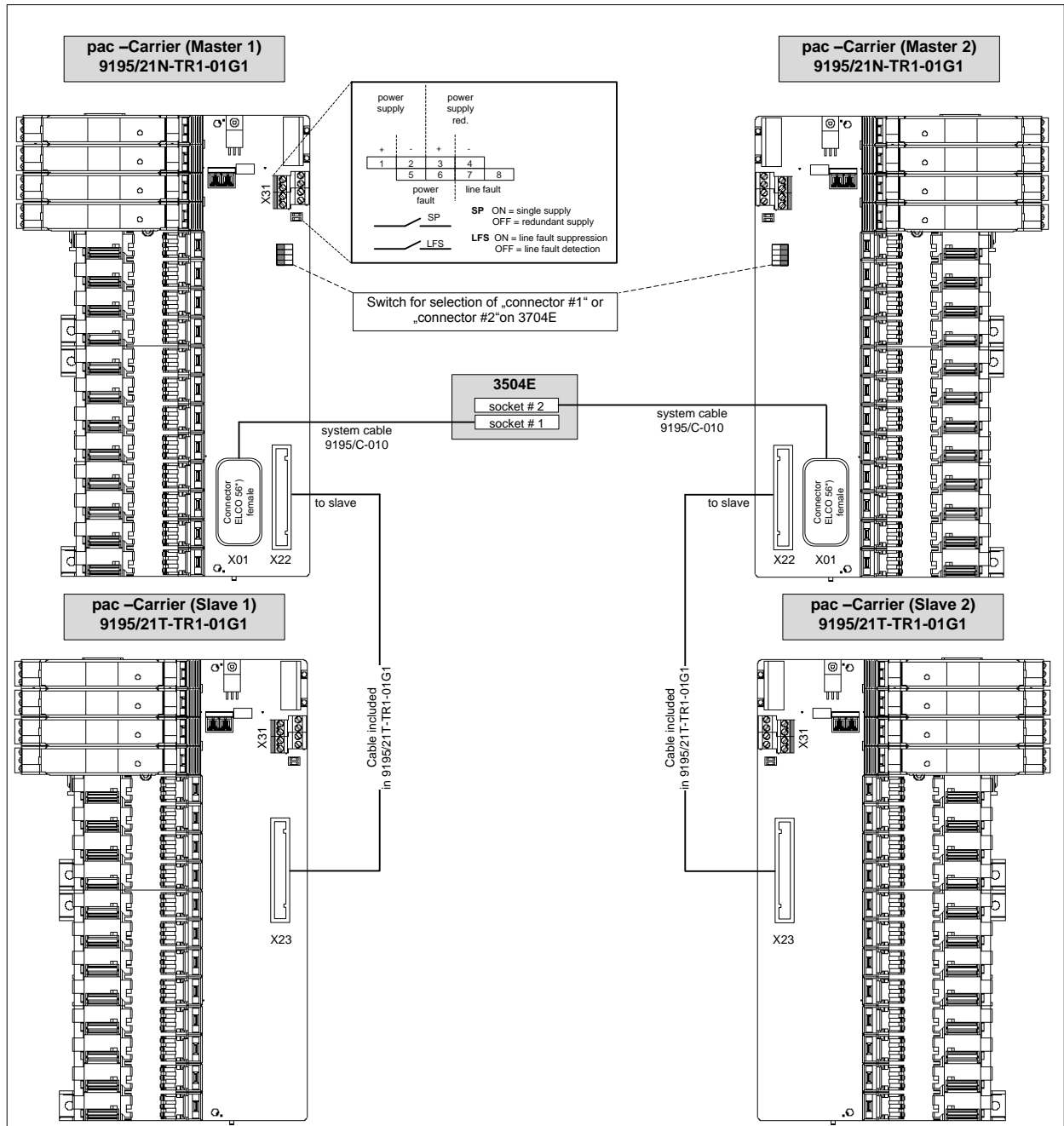

Selection table						
Control system				pac-Carrier		
DLS manufacturer	DLS type	I/O cards type	Signal type	Slots	System cable	Type
Triconex	Version 9 Tricon System	3704E	DI	2 x 16	2 x 9195/C-017	2 x 9195/21N-TR1-01G1
				2 x 16	--	2 x 9195/21T-TR1-01G1
Technical data						
Certificates			BVS 03 ATEX E213 X			
Explosion protection			⊕ II 3 G Ex nA nC II T4			
Installation			In Zone 2, Div. 2 and in the safe area			
Power supply			(X31)			
Nominal voltage U_N			24 V DC (19 V ... 31,2 V)			
Redundant supply			yes, decoupled with diodes			
Indication			2 LED green „PWR1“; „PWR2“			
Fuse			2 x TR5; T 2,0 A; exchangeable, for primary and redundant supply			
Polarity reversal protection			yes			
Connection to automation system			(X01)			
Connection			ELCO 56 female, Key-Code: Small 1, Large 5			
Number of channels			32			
Connection field devices – Ex i / I.S.						
Connection			at the terminals of the Ex i isolators (see “signal loops”)			
Number of channels			16			
Connection to SLAVE carrier			(X22)			
Connection			IEC 60603-13 (DIN 41651) 34 pole, male			
Number of channels			16			
Connection to MASTER carrier			(X23)			
Connection			IEC 60603-13 (DIN 41651) 34 pole, male			
Number of channels			16			
Error messaging			(X31)			
Power supply failure PF			Contact (35 V / 100 mA), closed in good conditions			
Line fault LF (of IS pac modules)			Contact (35 V / 100 mA), closed in good conditions			
Setting switch „SP“			Power failure message suppressed for redundant supply (single supply)			
Setting switch „LFS“			Line fault message suppressed			
Ambient conditions						
Ambient temperature			max. - 20 °C ... + 70 °C (see specification of Ex i isolators)			
Storage temperature			- 40 °C ... + 80 °C			
Relative humidity (no condensation)			≤95 %			
Mechanical data						
Weight			approx. 320 g			
Mounting type			on DIN rail (NS35 / 15, NS35 / 7.5) or mounting plate (4 x screw M6)			
Mounting position			horizontal or vertical			
Casing / Terminal protection class			IP 00 / IP 20			
Casing material			PA 6.6			
Fire protecting class (UL-94)			V0			

Signal loops

The diagrams below show typical applications. Please refer to the connection list to get the entire connection scheme. Basic technical parameters of the ISpac isolating repeaters can be found at the end of this document. The detailed specifications can be downloaded at: www.ispac.info.

Transmitter supply unit (AI)
for 2-,3- wire transmitter and mA- sources
for 2- wire transmitter with HART

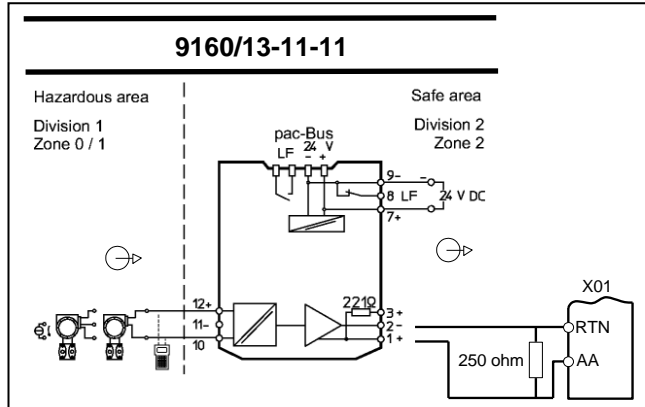

Isolating repeater (AI)
for 4- wire transmitter and mA- sources
bi- directional HART communication

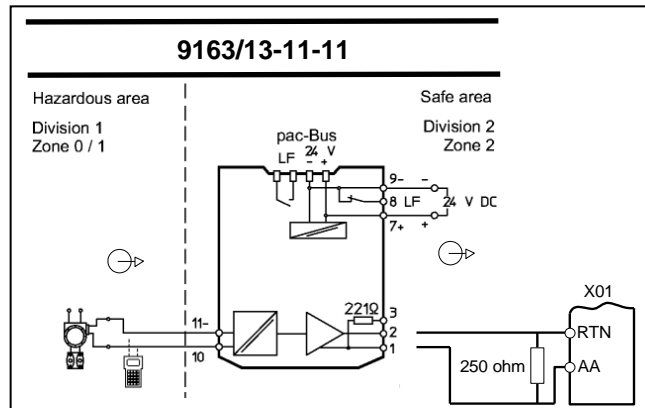

Temperature transmitter (AI)
for resistance thermometer,
thermocouple and RTD
(Configuration by means of ISpac Wizard software)
(Verification test with SIS 1508 pending)

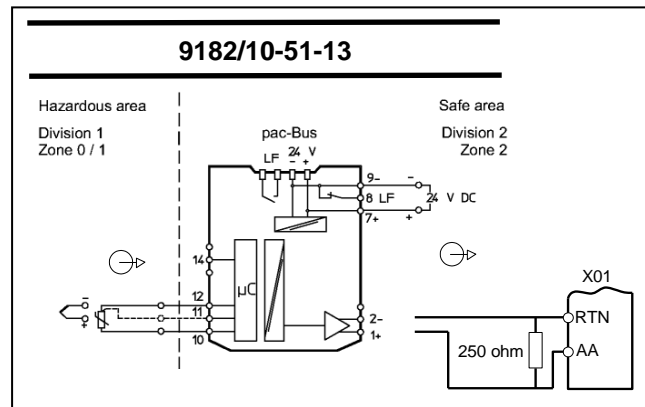



SIL specification

ISpac type	Function	SIL	Tested by	Test report Number	SFF	PFD	Tproof
9195/16M-TR1-01G1 9195/16S-TR1-01H1		3	EXIDA	Stahl 04/04-03 R002 (V1, Rev. R1.0)	91%	2.04E-05	10
9160/13-11-11	AI	2	EXIDA	Stahl 05/08-34 R008 (V2, Rev. R2)	73%	4,64E-04	1
9163/13-11-11	AI	2	EXIDA	Stahl 08/10-21 R015 (V1, Rev. R0)	77.5%	4,62E-04	1
9182/10-51-13	TI	2	EXIDA	Stahl 07/07-23 R016 (V1, Rev. R1)	78%	7.59E-04	1

The pac-Carrier type 9195 is considered as wiring within the SIF.

Accessories and Spare Parts

Designation	Illustration	Description	Order number
Non-Ex i Termination Module	 06314E00	The termination module is used to integrate non-Ex i field circuit into the system integration solution pac-Carrier type 9195. In such a way it enables a flexible mixture of Ex i and non-Ex i field circuits.	9191/20-00-50s
Cover 17,6 yellow transparent (10 pieces)	 01955E00	The yellow covers mark the isolators used for SIL applications. Delivered in packages of 10 pieces.	200914

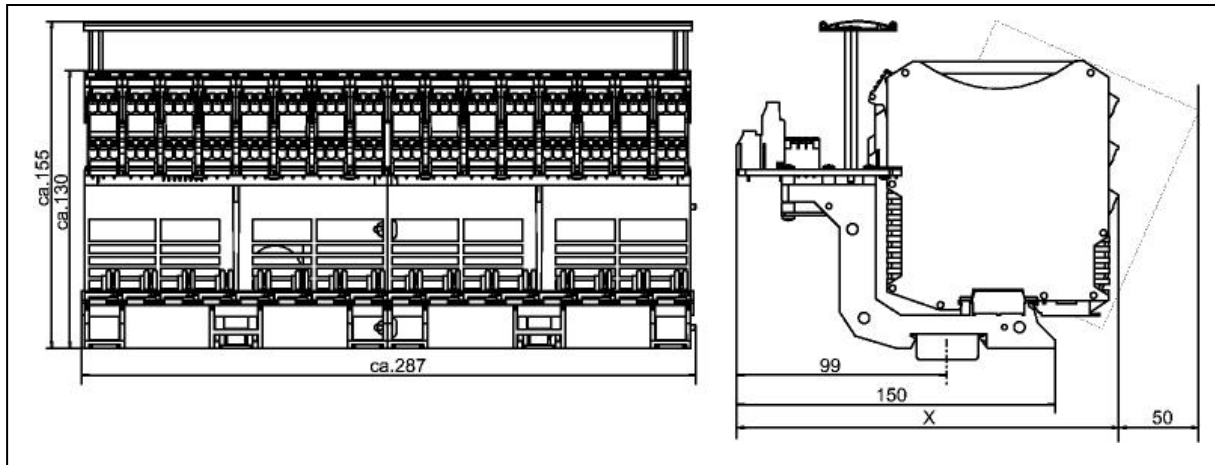

Dimension drawings (all dimensions in mm) - subject to alterations

05178E00

	Dimension x
Screw terminals	196 mm
Cage clamp terminals	206 mm

Please note: In order to snap in the ISpac modules an extra space of approx. 50 mm is required.
Please read the "ISpac engineering guideline" carefully before you start to engineer the enclosures with incorporated ISpac modules with or without pac-Carriers. The "ISpac engineering guideline" can be downloaded from: www.ispac.info.

Connection list
**Connection list – Master 1 and 2
TRICONEX Module 3704E (AI 64, 0-5 V)**

terminal I.S.		channel	carrier slot	carrier	input no.	pin X01 conn. # 1 (Elco 56 female)	terminal I.S.		channel	carrier slot	carrier	input no.	pin X01 conn. # 2 (Elco 56 female)
1)							1)						
10	+	1	1	Master 1	1	AA	10	+	33	1	Master 2	33	AA
11	-						11	-					
10	+	2	2		2	LL	10	+	34	2		34	LL
11	-						11	-					
10	+	3	3		3	z	10	+	35	3		35	z
11	-						11	-					
10	+	4	4		4	EE	10	+	36	4		36	EE
11	-						11	-					
10	+	5	5		5	p	10	+	37	5		37	p
11	-						11	-					
10	+	6	6		6	v	10	+	38	6		38	v
11	-						11	-					
10	+	7	7		7	h	10	+	39	7		39	h
11	-						11	-					
10	+	8	8		8	l	10	+	40	8		40	l
11	-						11	-					
10	+	9	9	9	e	10	+	41	9	41	e		
11	-					11	-					41	-
10	+	10	10	10	b	10	+	42	10	42	b		
11	-					11	-					42	-
10	+	11	11	11	W	10	+	43	11	43	W		
11	-					11	-					43	-
10	+	12	12	12	S	10	+	44	12	44	S		
11	-					11	-					44	-
10	+	13	13	13	L	10	+	45	13	45	L		
11	-					11	-					45	-
10	+	14	14	14	F	10	+	46	14	46	F		
11	-					11	-					46	-
10	+	15	15	15	M	10	+	47	15	47	M		
11	-					11	-					47	-
10	+	16	16	16	B	10	+	48	16	48	B		
11	-					11	-					48	-

Connection list – Slave 1 and 2

terminal I.S. 1)		channel	carrier slot	carrier	input no.	pin X01 conn. # 1 (Elco 56 female)	terminal I.S. 1)		channel	carrier slot	carrier	input no.	pin X01 conn. # 2 (Elco 56 female)
10	+	17	1	Slave 1	17	BB	10	+	49	1	Slave 2	49	BB
11	-						11	-					
10	+	18	2		18	MM	10	+	51	3		51	CC
11	-						11	-					
10	+	19	3		19	CC	10	+	53	5		53	t
11	-						11	-					
10	+	20	4		20	HH	10	+	55	7		55	j
11	-						11	-					
10	+	21	5		21	t	10	+	57	9		57	f
11	-						11	-					
10	+	22	6		22	x	10	+	59	11		59	Z
11	-						11	-					
10	+	23	7		23	j	10	+	61	13		61	P
11	-						11	-					
10	+	24	8		24	m	10	+	63	15		63	N
11	-						11	-					
10	+	25	9	25	f	10	+	64	16	64	C		
11	-					11	-						
10	+	26	10	26	c								
11	-					11	-						
10	+	27	11	27	Z								
11	-					11	-						
10	+	28	12	28	U								
11	-					11	-						
10	+	29	13	29	P								
11	-					11	-						
10	+	30	14	30	J								
11	-					11	-						
10	+	31	15	31	N								
11	-					11	-						
10	+	32	16	32	C								
11	-					11	-						



We reserve the right to make alterations to the technical data, weights, dimensions, designs and products available without notice.
The illustration cannot be considered binding.

Notes:



**R. STAHL Schaltgeräte GmbH**

Am Bahnhof 30, D-74638 Waldenburg, Germany

Telefon +49 7942 943-0

Telefax +49 7942 943-4333

E-Mail: info.ex@stahl.de

Internet: <http://www.stahl.de>

S – EG / EP – 9195 – 04 – en – 01 / 2012